



+ Custom made design

GOODWOOD's panels are fully personalisable (colours, materials, decorative film) to match the decor of any room.

+ Lighting

GOODWOOD let you have an individual wall-mounted lighting unit for each bed (GOODLIGHT, LYSA, LUMIA) or an integrated cap incorporating the light sources.



TECHNICAL FEATURES

The GOODWOOD architectural concept offers many possible options for integrating electrical and medical gas equipment. Thanks to its slim profile, it is easy to integrate into your caring area. It can also be equipped with an optional stainless steel accessory mounting rail (25x10 mm).

1 bed standard configuration

Front view

GOODWOOD with GOODLIGHT or LYSA lighting unit

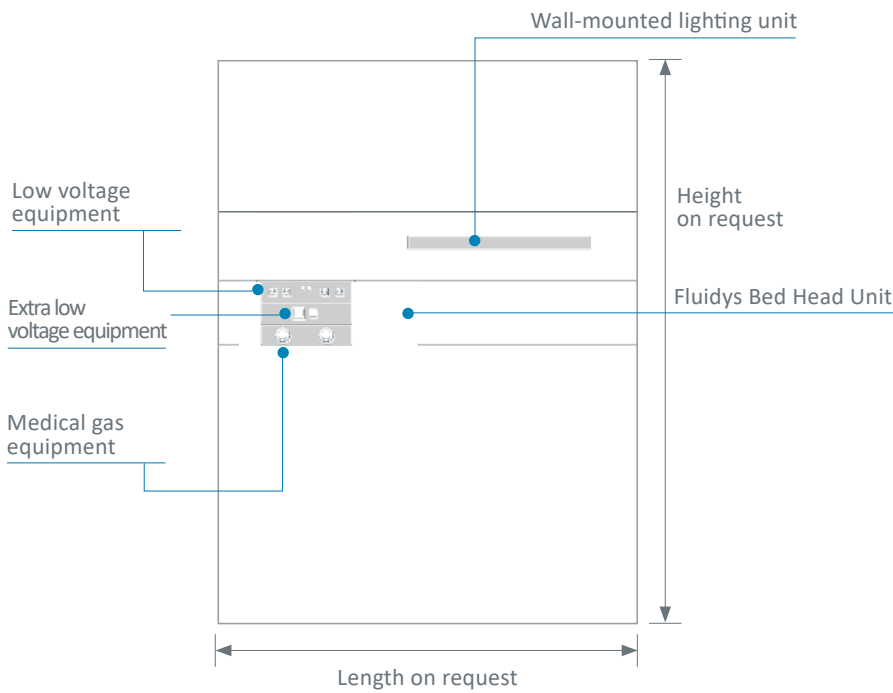

Side view

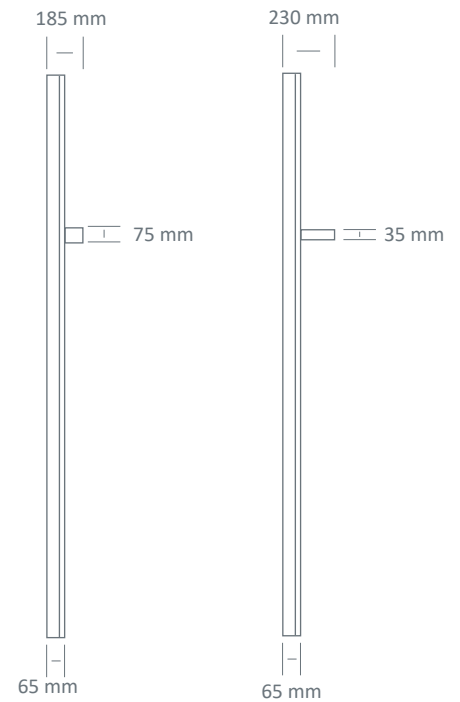

GOODWOOD with GOODLIGHT or LYSA lighting unit

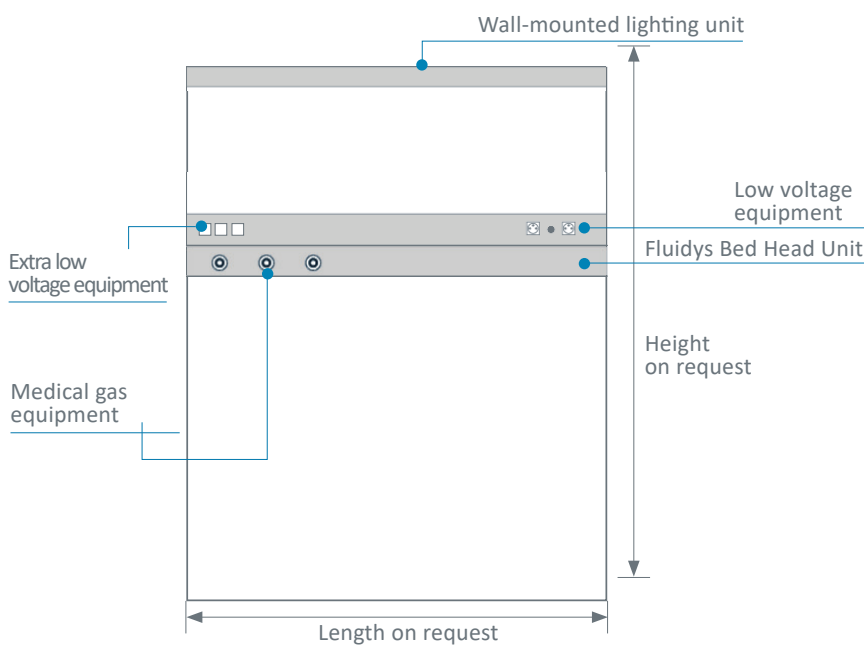

GOODLIGHT

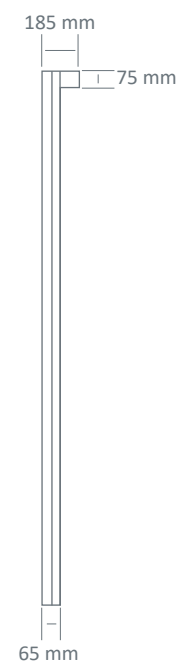

LYSA

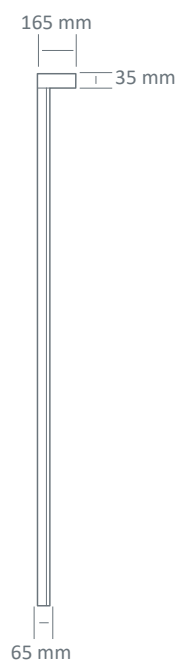

For the different colors and possible customizations, consult our architectural colour chart page 5.

Power supply

It is designed to be fed:

From behind

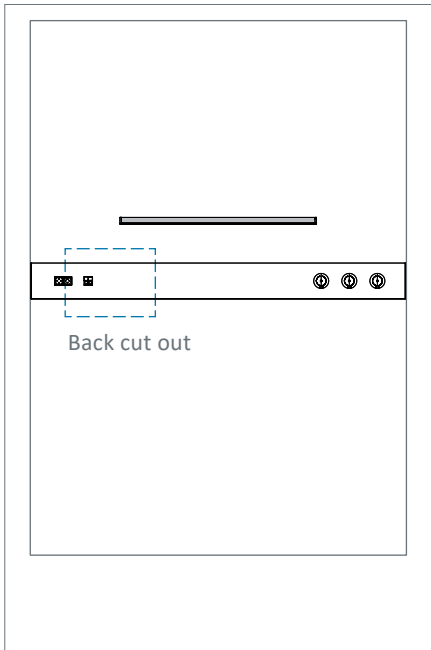

From the ceiling

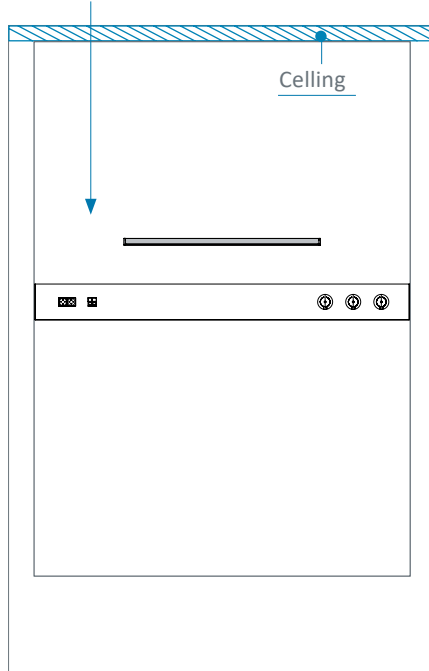

From the side, via a distribution duct

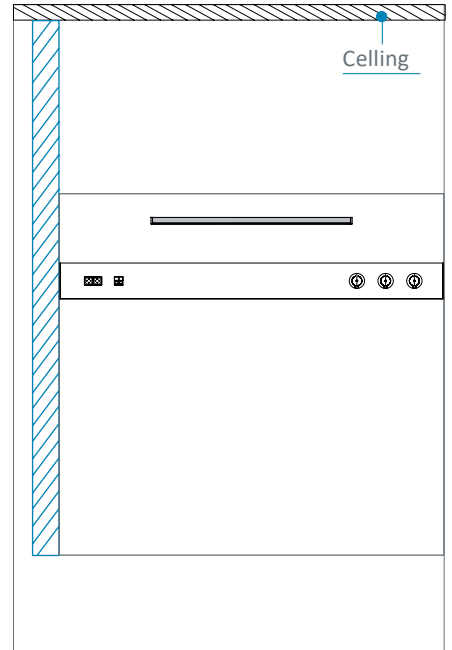

Electrical equipment integration

The waterjet cutting of the GOODWOOD's cover enables exact and customized cutting. It can integrate all forms of outlets. Flush mounting of electrical equipment enables easier cleaning and disinfection of the product.



Medical gas integration

ABS / PC medical gas casings are available with a flap for AFNOR gas outlets.











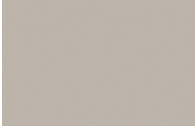
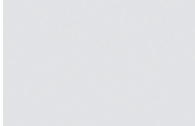

TECHNICAL FEATURES

Standard colours

The GOODWOOD architectural concept offers a wide range of colours.
Panels have an antibacterial Sanitized® treatment.











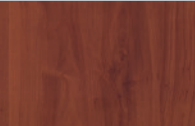

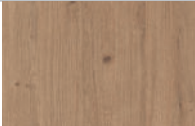
Colors

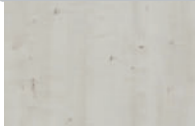
 Blue B086 Finish: FA	 Beige B116 Finish : FA	 White B117 Finish : FA	 Blue B124 Finish : FA	 Blue C118 Finish : FA	 Céladon C190 Finish : FA
 Smoke F008 Finish : FA	 Gray G044 Finish : FA	 Orange G078 Finish: FA	 Yellow J018 Finish : FA	 Green P092 Finish: FA	 Pink R058 Finish : FA

More colors available at <https://www.polyrey.com/collection/unis>

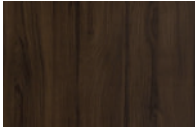
Woods

 Pecan Wood B023 Finish : FA	 Washed Oak C103 Finish : SEV	 Vendome Oak C133 Finish : SEV	 Natural Cherry tree C181 Finish : EXM	 Northern Maple E028 Finish : FA	 Faroese Maple E103 Finish : EXM
 Crystal Ash F058 Finish : SEV	 Monreale Ash F061 Finish : SEV	 Bergen Beech H028 Finish : SEV	 Natural Hazel N056 Finish : EXM	 Walnut Havana N114 Finish : EXM	 Appalachian Walnut N118 Finish : EXM

More colors available at <https://www.polyrey.com/collection/bois>

FA Finish: Light satin finish with an extra fine grain and soft texture

EXM Finish: Extra matt with a rough texture that recreates the authenticity of the original materials

SEV Finish: The fibre of wood underpinned by a subtly irregular and silky grained surface

NB : The colors shown here may differ from finished products.

Contact our sales force to view our samples.

You can receive them within 48 hours.

TECHNICAL FEATURES

GOODWOOD with integrated aluminum profile

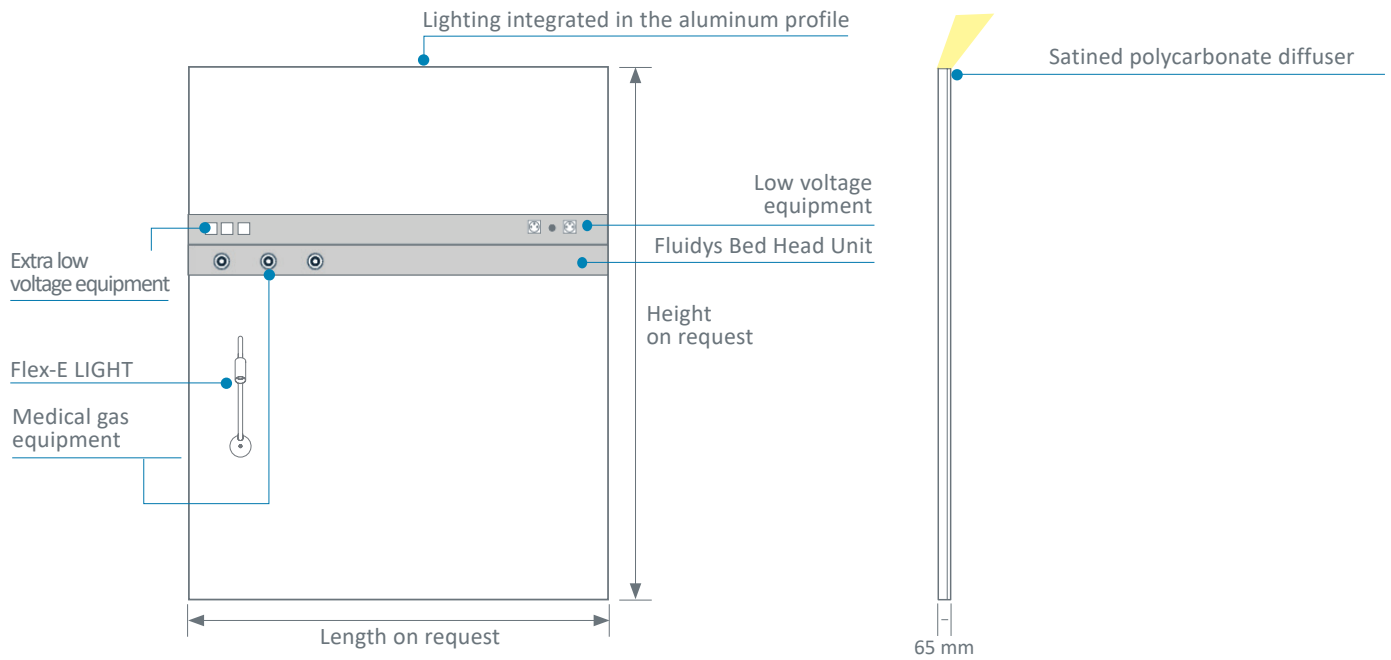

See the colors of laminated panels, see page 5.

CONFIGURATION EXAMPLES



1-bed Goodwood with Lysa wall lighting unit



1-bed Goodwood with Goodlight wall lighting unit



1-bed Goodwood with Goodlight wall lighting unit and accessory mounting rail



Goodwood with lighting integrated RGB option



CONTROLLED LIGHTING

The GOODWOOD concept offers lighting unit on the front panel, or a GOODLIGHT unit overhanging its front panel. It also incorporates LED night light at the bottom.

High-performance and controlled lighting

The high-performance reflectors in the general and reading light units offer high efficiency and direct the light towards the middle of the room and onto the reading surface.

Comfortable lighting

The general and reading lights are less likely to dazzle the patient, medical personnel, or visitors, because the sources are not directly visible.

General lighting

- Clear satin-finish PMMA diffuser with anti-UV treatment
- MIRO 20 SILVER® Aluminum reflector (for LYSA and GOODLIGHT)

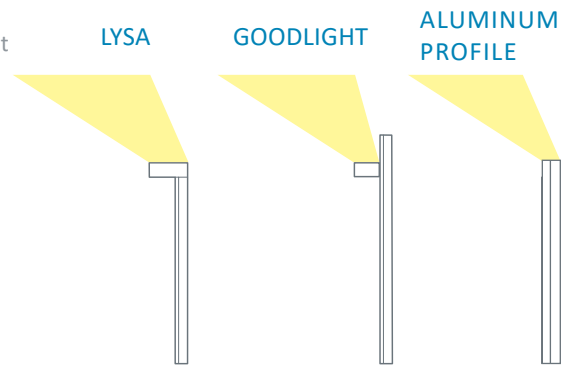

Reading lighting

- Satin-finish PMMA diffuser
- MIRO 20 SILVER® Aluminum reflector (for LYSA and GOODLIGHT)

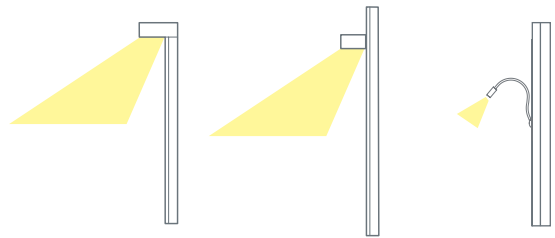

Caring lighting

Caring lighting combines direct (reading) and indirect (general) lighting.

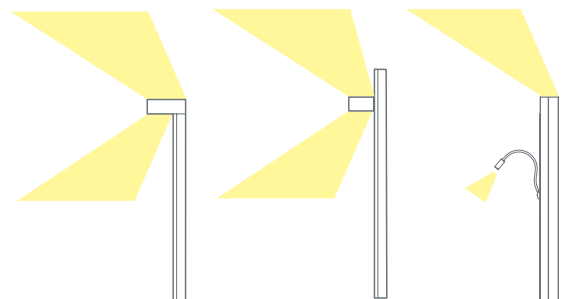

* Polymethylmethacrylate

EFFICIENT LIGHTING

Lighting study

- Standard room
- Dimensions of the room: 3 m x 3 m, ceiling clearance 2.5 m
- Reflection coefficients: ceiling 7, walls 5, and floor 3
- Coefficient of depreciation 0.83

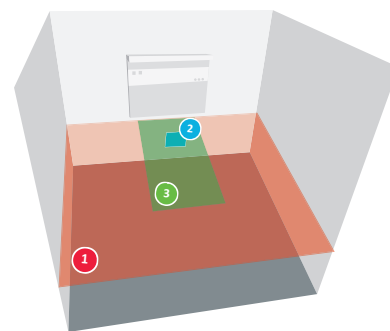

GOODLIGHT lighting unit

General lighting

Virtual general lighting plane of a surface equal to the one of the room, located 0.85 m above the floor (3 m x 3 m for a single room).

Reading lighting

Virtual reading plane 0.3 m x 0.3 m inclined at 75° located 1.1 m from the floor and 1 m from the wall where the light fitting is mounted.

Caring lighting

Virtual examination plane 2 m x 0.9 m located 0.85 m from the floor, centred in width and 0.1 m from the wall.

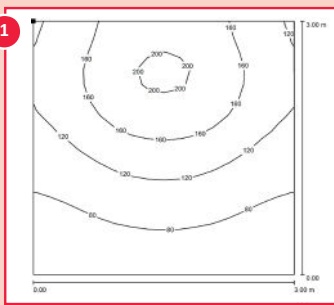
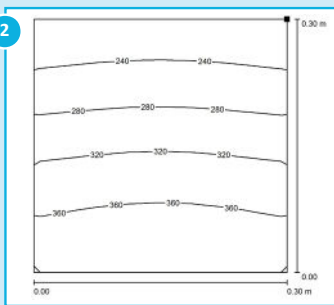
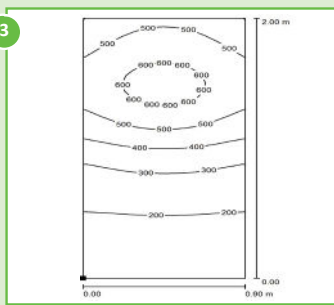
LED	3 ft module	2 ft module	General and reading lighting combined
			
Consumption	33,2 W	10,8 W	44 W
Average lighting	132 lx	345 lx	379 lx

Lighting power (LYSA or GOODLIGHT)

Lighting	Modules power	Types of sources	Color temperature	Luminous Flux ⁽¹⁾	Consumption	System Efficiency	Driver(s)
General lighting	28,7 W (3 Ft)	LED	3000 K 4000 K	5039 lm	33,2 W	151,9 lm/W	Fixed / DALI
General lighting (Dynamic lighting)	38,9 W (3 Ft)	LED	2700 K to 6500 K	5000 lm	44,9 W	111,4 lm/W	DALI
Reading lighting	8,9 W (2 Ft)	LED	3000 K 4000 K	1710 lm	10,8 W	158,8 lm/W	Fixed / DALI
Night light	1 x 3,1 W	LED	3000 K	292 lm	3,3 W	89,8 lm/W	Fixed

- Luminous flux maintenance factor : L80B10 to 60 000 hours
- MacAdam Ellipse: 3 SDCM
- LED sources photobiological risk : GP1

⁽¹⁾ All the luminous flux indicated in the brochure are based on the flux of the LED modules also known as system flux.

Luminaire output flux = (Module flux) x (optical efficiency), the optical efficiency of the luminaire is indicated in the Eulumdat file (LDT line 23) available for download on our website or on request.



Dynamic Lighting



The GOODLIGHT wall lighting unit is available with dynamic lighting.

For more information, please read the dedicated brochure.

Norms & certifications

- EN ISO 13485: Quality management systems
- CE Medical Devices Marking according to the (EU) Rules 2017/745
- EN ISO 11197: Medical supply units
- EN ISO 7396-1: Medical gas pipeline systems - Part 1
- European rules for caring centers lighting

Bed head units, Wall lighting units, Ceiling pendants, Suspended Beams & Columns,
Special care bed head units, Sealed lightings, Medical gas monitoring & Biomedical Accessories

