



CARE AND EXAMINATION LAMPS

LED



Care LED lamp with gradation on articulated arm with clamp

This lamp is really convenient for examinations and is suitable for resuscitation ward or patient rooms.

Length : 885 mm
Light output 30000 Lux / 0,5 m
Field of illumination 300 mm / 0,5 m
Color temperature 4400 K
CRI > 93

For horizontal rail, ref : 815652

For vertical tube or rail, ref : 815653

LED



Care LED lamp on articulated arm

This lamp can be used in examination rooms or ICU. It provides reliable and ideal lighting for medical examinations.

1 color temperature, with clamp

Length : 940 mm
Light output 50000 Lux / 0,5 m
Field of illumination 180 mm
Color temperature 4 400 K
CRI > 93

For horizontal rail, ref : 815654

For vertical tube or rail, ref : 815655

3 color temperatures, with clamp, 5 gradation level

Light output 50000 Lux / 0,5 m
Field of illumination 180 mm
Color temperature 3 300 K / 3 800 K / 4 400 K
CRI > 93

For horizontal rail, ref : 815656

For vertical tube or rail, ref : 815657

LED



LED lamp on flexible arm

This lamp is suitable for daily medical examinations.

Length : 1000 mm
Light output 50000 Lux / 0,5 m
Field of illumination 180 mm
Color temperature 4 400 K
CRI > 93

For horizontal rail, ref : 815714

For vertical tube or rail, ref : 815715

CARE AND EXAMINATION LAMPS



LED lamp on articulated arm with clamp

Length : 991 mm
Light output 50000 Lux / 0,5 m
Field of illumination 100 mm
Color temperature 4 300 K

For horizontal rail, ref : 815662

For vertical tube or rail, ref : 815663



LED minor ops and examination lamp with double joint rigid arm (clamp included)

This care lamp is ideal for emergencies, neonatology or in addition in operating rooms for small or ambulatory surgeries. It can be screwed onto the ceiling anchoring of the TECH-CARE pendant.

Length : 1750 mm (+ tige verticale min 700 - max 1200)
Light output 80000 Lux / 1m
Field of illumination 180 mm
Color temperature 4 500 K
CRI > 95

For ceiling mounting, ref : 815706

For wall mounting, ref : 815707



Wall-mounted LED lamp

Length : 1850 mm
Light output > 40000 Lux / 1 m
Field of illumination < 240 mm
Color temperature 4 500 K

Ref : 519143

EXAMINATION LAMPS

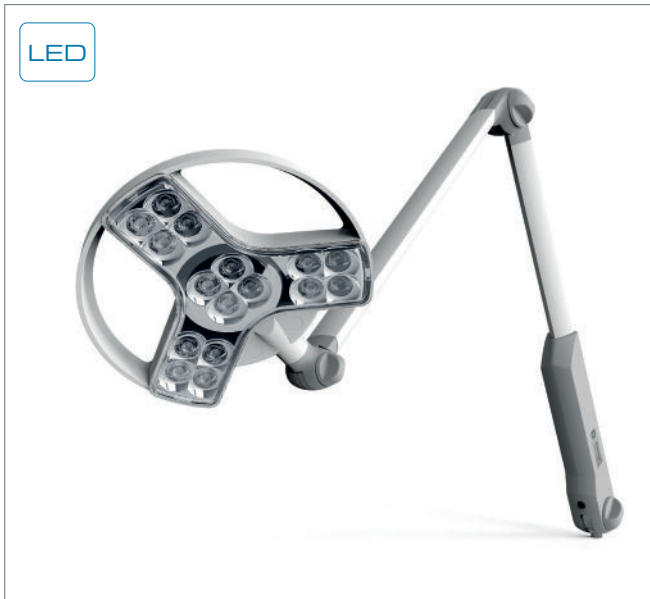

LED lamp on articulated arm, 2 color temperatures with clamp, 4 gradation level

This lamp is perfect for sensitive areas like neonatology or ICU/Resuscitation.

Length : 1080 mm

Light output 60000 Lux / 0,5 m

Field of illumination 210 mm

Color temperature 3 500 K / 4 500 K

CRI > 93

For horizontal rail, ref : 815658

For vertical tube or rail, ref : 815659

CARE AND READING LAMPS



Care and reading LED lamp on flexible arm

It is particularly recommended for reading in the patient rooms of hospitals or retirement homes.

Length : 800 mm

Light output 1100 Lux / 0,5 m

Field of illumination 600 mm

Color temperature 3 000 K

CRI > 80

For horizontal rail, ref : 815708

For vertical tube or rail, ref : 815709

As option:

This lamp is available without switch. In this case the control will be done directly from the nurse call pear.

For horizontal rail, ref : 815710

For vertical tube or rail, ref : 815711



Care and reading LED lamp on flexible arm

This lamp is mainly used for reading in retirement homes. The handle integrates a luminous ON/OFF switch. It enables easy use and positioning.

Length : 820 mm

Light output 1000 Lux / 0,5 m

Field of illumination 450 mm

Color temperature 3 000 K

CRI > 95

For horizontal rail, ref : 815712

For vertical tube or rail, ref : 815713

TILTING SWIVEL ARM FOR SCREEN / MONITOR

Monitor stand

Swivel arm, length 300 mm, for VESA quick-fit panel (18 kg max.)



For horizontal rail, ref : 511508



For wall vertical rail, ref : 511510



For vertical Ø38 tube, ref : 519126

Swivel arm, length 300+300 mm, for VESA quick-fit panel (18 kg max.)



For horizontal rail, ref : 511509



For vertical rail, ref : 511511



For vertical Ø38 tube, ref : 511524

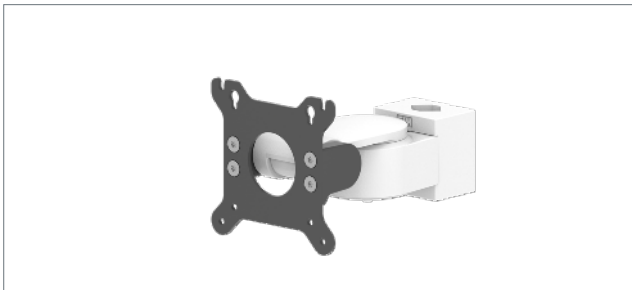

VESA 75 / 100 mm monitor stand on clamp for tube (Ø 23-40 mm)

Ref : 815489

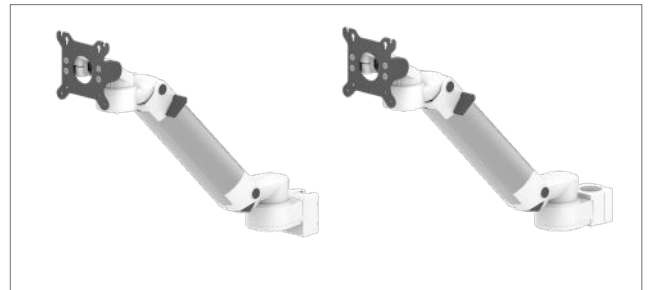

Height-adjustable arm, 450 mm offset, vertical travel 438 mm for VESA screen (max 16 kg).

For vertical rail, ref : 511512

For vertical Ø38 tube, ref : 511525

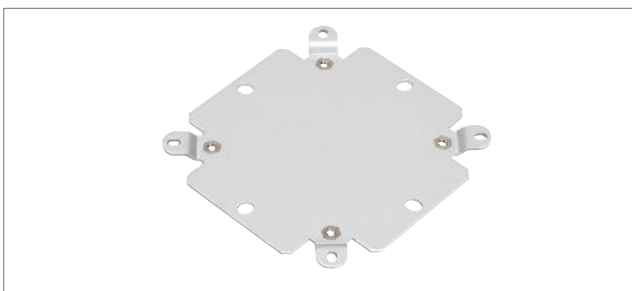

VESA quick adapter panel

Ref : 519131

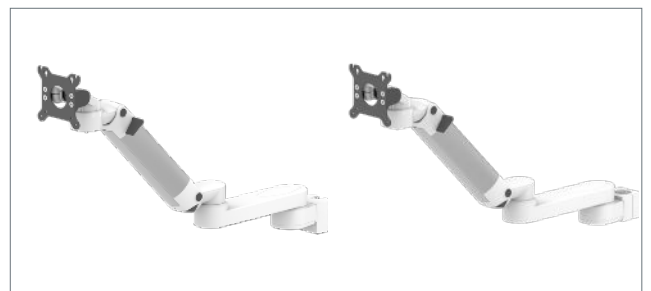

Height-adjustable arm, 450 mm offset, vertical travel 438 mm with 230 mm extension for VESA screen (max 18 kg).

For vertical rail, ref : 511513

For vertical Ø38 tube, ref : 511526

TILTING SWIVEL ARM FOR KEYBOARD AND MOUSE

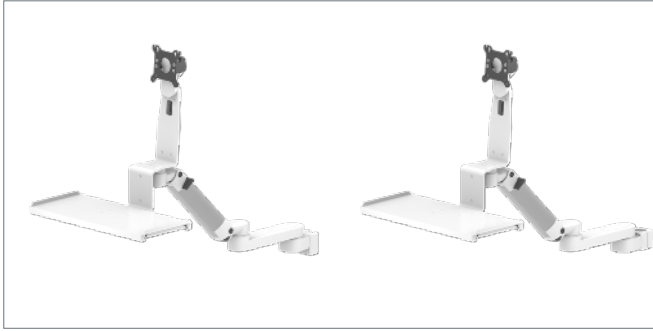

Height adjustable screen and keyboard stand, 450 mm offset, vertical travel 438 mm with 230 mm extension (max 17 kg)

For vertical rail, ref : 511514

For vertical Ø38 tube, ref : 511530

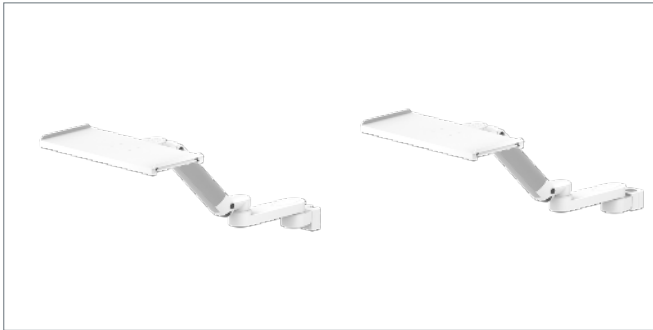

Height adjustable arm, 450 mm horizontal extension, vertical travel 438 mm with 230 mm extension (5kg maximum for the tray)

For vertical rail, ref : 511694

For vertical Ø38 tube, ref : 511695



Monitor/keyboard stand with height-adjustable work surface, 450 mm offset, 438 mm vertical travel (14 kg max)*

For vertical rail, ref : 511580

For vertical Ø38 tube, ref : 511577

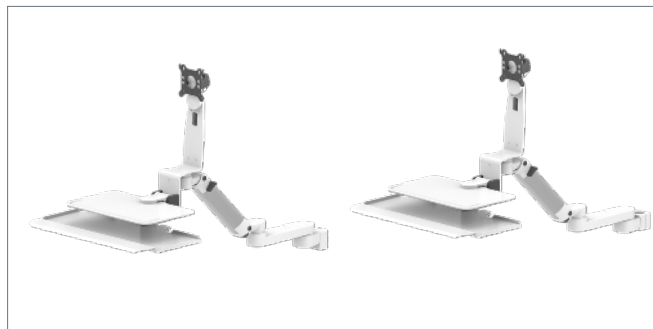

Monitor/keyboard stand with height-adjustable work surface, 450 mm offset, 438 mm vertical travel with 230 mm extension (14 kg max)*

For vertical rail, ref : 511578

For vertical Ø38 tube, ref : 511579

* for loads of less than 12,5 kg, please consult us.

TILTING SWIVEL ARM FOR KEYBOARD AND MOUSE



Height adjustable arm, 524 mm horizontal extension, vertical travel 330 mm (max 11,3 kg)

Load max : 9 kg

For vertical rail, ref : 815349

For vertical Ø38 tube, ref : 815339



Height adjustable arm, 524 mm horizontal extension, vertical travel 330 mm

For vertical rail, ref : 815350

For vertical Ø38 tube, ref : 815340



Height adjustable screen and keyboard stand with work surface 432 mm horizontal extension, vertical travel 508 mm (max 14,5 kg)

For vertical Ø38 tube, ref : 815687

ACCESSORIES

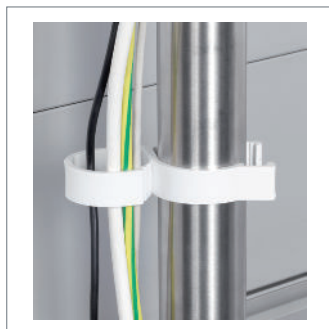

**Universal cable conduit
for 25x10 rail or Ø38
tube (batch of 4)**

Ref : 815121



Universal clamp

Ref : 519100



Ø25 tube clamp

Ref : 519101



Ø18 tube clamp

Ref : 519129



**Telescopic IV pole, 4 hooks
on arm with 300 mm
horizontal extension
Load max :
all 32 kg and 2 kg / hook**

For vertical rail or tube,
ref : 815487

For horizontal rail,
ref : 815196



**Secondary stainless steel
tube Ø25 x 1000 mm
on arm with 300 mm
horizontal extension
Load max : 28 kg**

For vertical rail or tube,
ref : 815125

For horizontal rail,
ref : 815526



**Set of two telescopic IV
poles, 4 hooks for Ø38
mono tube trolley
Load max :
all 32 kg and 2 kg / hook**

Ref : 815488



**Telescopic IV pole, 4
hooks for horizontal rail
Load max : 2 kg / hook**

Ref : 519108



**Telescopic IV pole, 6
hooks for horizontal rail
Load max : 2 kg / hook**

Ref : 519109



**Telescopic elbowed
IV pole, 3 hooks for
horizontal rail (bed head
unit or wall mounted)
Load max : 2 kg / hook**

Ref : 519110

ACCESSORIES



Telescopic elbowed IV pole, 4 hooks for horizontal rail (bed head unit or wall mounted)
Load max : 2 kg / hook

Ref : 519111



Telescopic IV pole, 4 hooks for horizontal rail
Load max : 2 kg / hook

Ref : 519112



Elbowed IV pole with 6 hooks
Load max : 3 kg

Ref : 815076



Articulated arm (approx. 1000 mm) with 4 hooks for Ø23 tube (clamp not included)

Ref : 519113



Monitor shelf, 540 x 360 mm / 40 kg

Ref : 519114



Monitor shelf, 540 x 360 mm / 40 kg with one 420 x 310 mm drawer

Ref : 519115



Monitor shelf, 540 x 360 mm / 40 kg with two 420 x 310 mm drawer

Ref : 519116



Off-center rail on clamp 25 x 10 x 355 mm
Load max : 14 kg

Ref : 519117



Centered rail on clamp 25 x 10 x 355 mm
Load max : 14 kg

Ref : 519118



Tilt shelf 300 x 300 mm on offset arm / 10 kg

Ref : 915083

ACCESSORIES



Shelf, 300 x 200 mm / 4 kg

Ref : 519134



**Fixed shelf,
365 x 290 mm / 15 kg**

Ref : 519061



**Folding shelf,
465 x 300 mm / 6 kg**

Ref : 519060



**Probe holder with one
compartment,
410 x 160 x 70 mm,
with 2 hooks for
horizontal rail**

Ref : 519056



**Probe holder with three
compartments,
510 x 380 x 70 mm,
with 2 hooks for
horizontal rail**

Ref : 519057



Document holder

Ref : 519066



**Stainless steel support
for 8 L bags**

Ref : 519063

8 L bags, Qty. 50

Ref : 519064

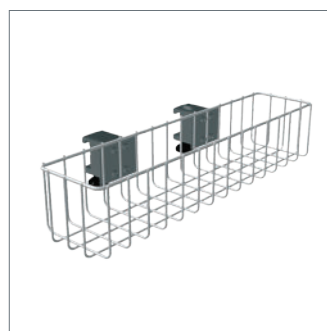

**Basket made of
powder-coated steel
500 x 120 x 100 mm with
2 clamps for horizontal
rail**

Ref : 519163

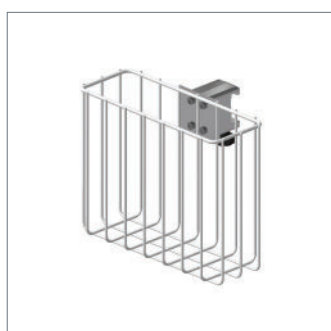

**Basket made of
powder-coated steel
250 x 90 x 200 mm with
clamp for horizontal rail**

Ref : 519162



**Glove box holder
260 x 132 x 100 mm with
clamp for horizontal rail**

Ref : 519128

ACCESSORIES



Glove box holder
200 x 134 x 90 mm with 2
hooks for horizontal rail

Ref : 519164



Mask stand

Ref : 519062



Double rail for shuttle
25 x 10 x 650 mm
Load max : 20 kg

Ref : 815104



**Jar-holder rail for vertical
box or Multicare. Load
max : 30 kg**

Ref : 815451

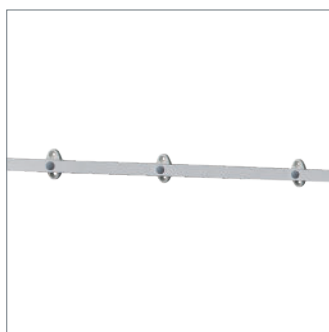

**Wall rail made of
aluminum 25 x 10 mm
(per meter)**

Ref : 815321



**Secondary stainless steel
tube Ø25 x 500 mm on
clamp**

Ref : 815126



**Secondary stainless steel
tube Ø38x1500 mm on
clamp for horizontal bed
head rail / wall rail
Load max : 30 kg**

Ref : 815127

**Secondary stainless steel
tube Ø38x1500 mm on
clamp for horizontal rails
Load max : 30 kg**

Ref : 815128



**Sliding trolley SM 60
Ø38 Mono tube (tray not
included)**

Ref : 815325

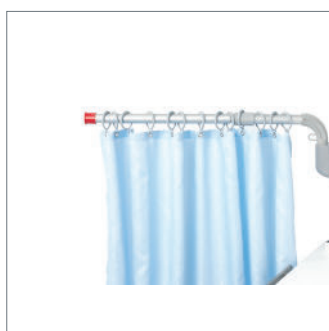

**View protection
assembly (140 x 120 cm)**

Ref : 519067

**View protection
assembly (230 x 140 cm)**

Ref : 519069



**Mounting interface
for view protection
assembly.**

For rail or Ø38 vertical
tube, ref : 815090

For horizontal rail,
ref : 815341

ACCESSORIES



Secondary stainless steel tube \varnothing 38 x 150 mm, for vertical rail

Ref : 815243



Extra tube system to hold accessories \varnothing 30

Réf : 815702

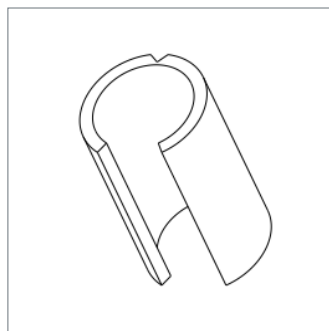

Adapter \varnothing 30 for tube \varnothing 38

Ref : 51088

ACCESSORIES



Nurse call pear push with normally open contact and two-pin plug

Close contact, ref : 517100
Open contact, ref : 517212

Four-function handset (general, reading, call + indicator light) with 10-pin plug

Ref : 517193

Two-function handset (reading, call + indicator light) with 10-pin plug

Ref : 517199

Three-function handset (general, reading, aux., call + indicator light) with 10-pin plug

Ref : 517190

Five-function handset (general, reading, up, down, call + indicator light) with 10-pin plug

Ref : 517191



DIN 10-pin plug on Mosaic 45 two-module support

Ref : 504017



Male/Female pull-out cord

Ref : 517200



Wall bracket for handset

Ref : 549150



Horizontal box handset

Ref : 517241



Stainless steel vertical tube support for accessories, dedicated to AXIS

Ref : 825317



Stainless steel tablet support for accessories, dedicated to AXIS

Ref : 825316



NATLYS circulation lighting

Ref : 891230

ACCESSORIES

Tray(s) / drawer(s) for column, box, bed head unit or \varnothing 38 tube

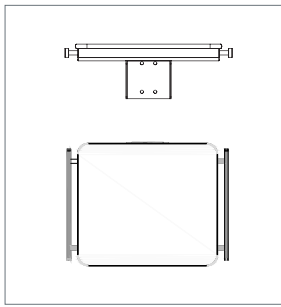

Tray 405x355 mm with lateral rail without mount (40 kg max)

Compact white finish
Ref : 815671

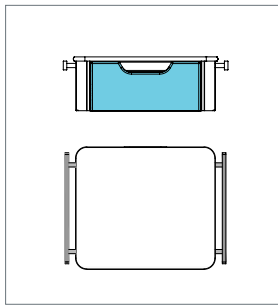

Tray unit 405x355 mm with single drawer and lateral rails without mount (40 kg max)

Compact white finish
Ref : 815673

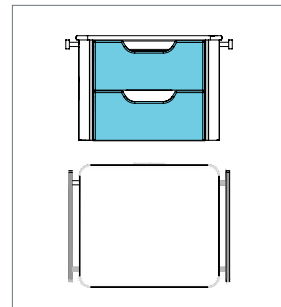

Tray unit 405x355 mm with double drawer and lateral rails without mount (40 kg max)

Compact white finish
Ref : 815675

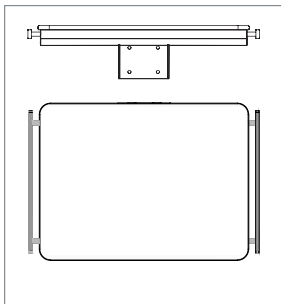

Tray 605x455 mm with lateral rails without mount (60 kg max)

Compact white finish
Ref : 815677

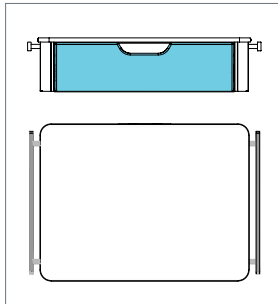

Tray unit 605x455 mm with single drawer and lateral rails without mount (60 kg max)

Compact white finish
Ref : 815679

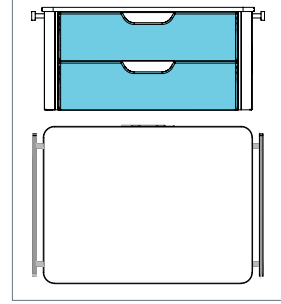

Tray unit 605x455 mm with double drawer and lateral rails without mount (60 kg max)

Compact white finish
Ref : 815681

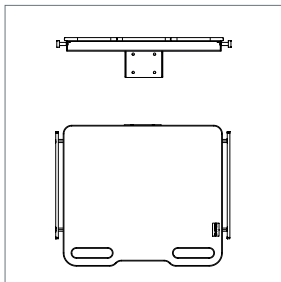

Tray unit 605x455 mm with lateral rails with handles (60 kg max)

Compact white finish
Ref : 815648

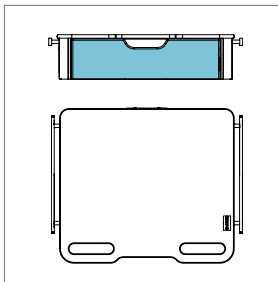

Tray unit 605x455 mm with single drawer and lateral rails with handles (60 kg max)

Compact white finish
Ref : 815649

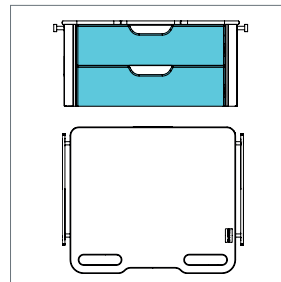

Tray unit 605x455 mm with double drawer and lateral rails with handles (60 kg max)

Compact white finish
Ref : 815650

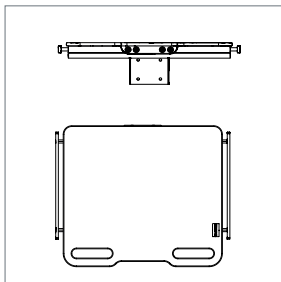

Tray unit 605x455 mm with lateral rails with handles and control buttons (60 kg max)

Compact white finish

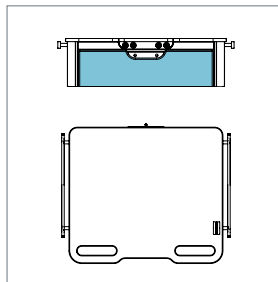

Tray unit 605x455 mm with single drawer and lateral rails with handles and control buttons (60 kg max)

Compact white finish
Ref : contact us

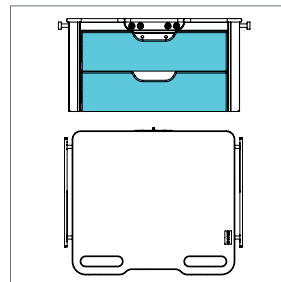

Tray unit 605x455 mm with double drawer and lateral rails with handles and control buttons (60 kg max)

Compact white finish
Ref : contact us

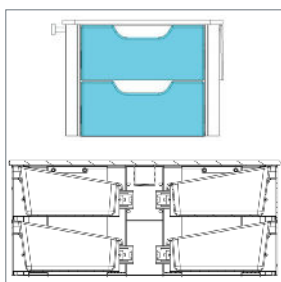

Tray unit 687x405 mm with double drawer and front rails without mount (60 kg max). Matching 815683, 815685 and 815686 mounting interface.

Compact white finish
Ref : 815717

Optional : key or code lock – Contact us for more information.

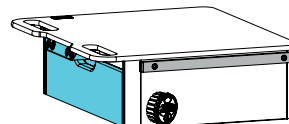
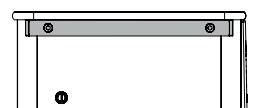
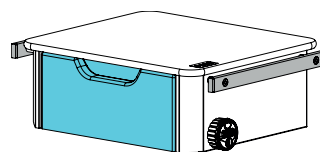

ACCESSOIRES

Choose the mounting interface to fit your tray and drawer units :

Mounting interface for trays/drawers unit 400 x 355 mm for single vertical rail - Ref : 815682

Mounting interface for trays/drawers unit 605x455 mm for MULTICARE column and vertical box TECH-CARE - Ref : 815683

Mounting interface for vertical Ø38 tube - Ref : 815684

Mounting interface for mono FLUIDYS T with 2 lateral rails - Ref : 815685

Mounting interface for duo FLUIDYS T with 2 lateral rails - Ref : 815686

Tray(s) / drawer(s) for trolley or horizontal box

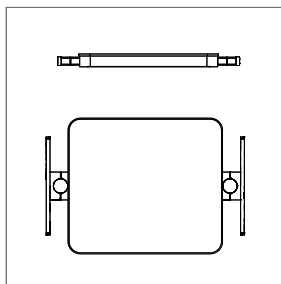

Tray 405x355 mm, with lateral rails (40 kg max)

Compact white finish
Ref : 815624

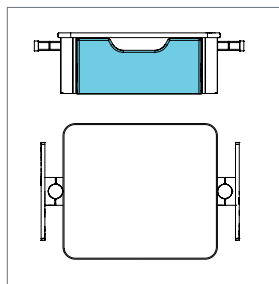

Tray unit 405x355 mm with single drawer and lateral rails (40 kg max)

Compact white finish
Ref : 815630

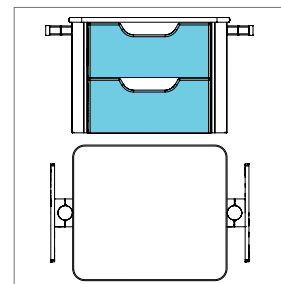

Tray unit 405x355 mm with double drawer and lateral rails (40 kg max)

Compact white finish
Ref : 815632

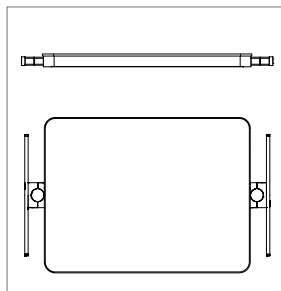

Tray 605x455 mm with lateral rails (60 kg max)

Compact white finish
Ref : 815622

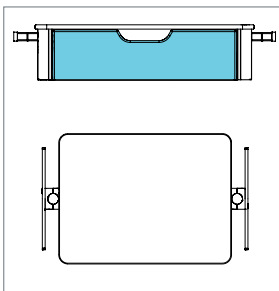

Tray unit 605x455 mm with single drawer and lateral rails (60 kg max)

Compact white finish
Ref : 815626

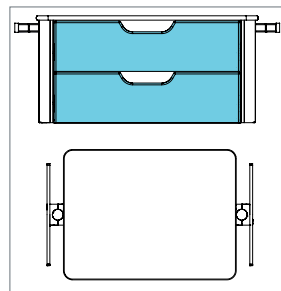

Tray unit 605x455 mm with double drawer and lateral rails (60 kg max)

Compact white finish
Ref : 815628

Norms & certifications

- 13485 Quality management systems
- CE Medical Devices Marking according to 93/42/EEC Directive
- EN ISO 11197 : Medical supply units
- EN ISO 7396-1 : Medical gas pipeline systems — Part 1
- European rules for caring centers lighting

Bed head units, Wall lighting units, Ceiling pendants, Suspended Beams & Columns,
Special care bed head units, Sealed lightings, Medical gas monitoring & Biomedical Accessories

